

SINKWARE & LAUNDRY UNITS



omnia

The Omnia range of contemporary sinkware is designed to suit your modern lifestyle

double bowl + double drainer

1380 x 480 x 180

1380S

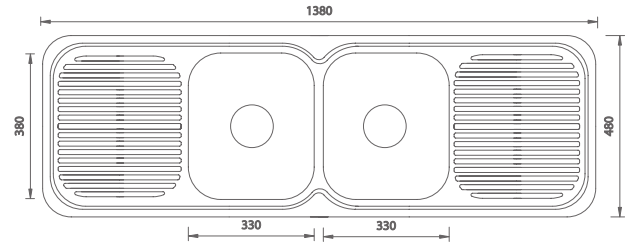

double bowl + single drainer

1180 x 480 x 180

LHB 1180SL &
RHB 1180SR

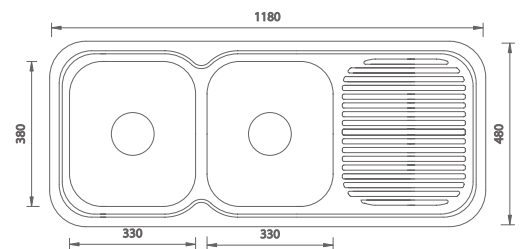

1 & ¾ bowl + single drainer

1080 x 480 x 180

LHB 1080SL &
RHB 1080SR

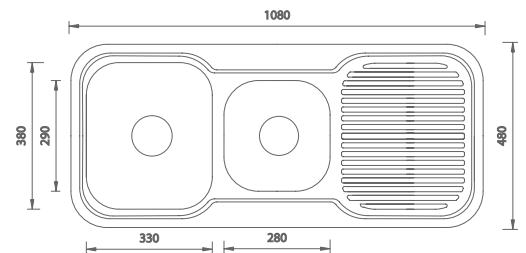
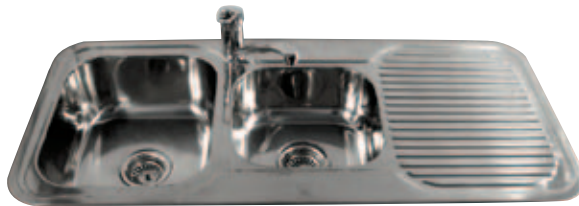

1 & ½ bowl + single drainer

980 x 480 x 180

LHB 980SL &
RHB 980SR

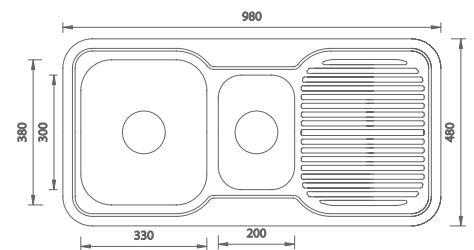
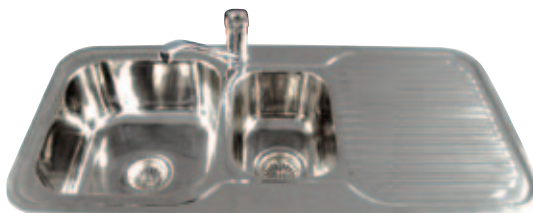

single bowl + single drainer

780 x 480 x 180

LHB 780SL &
RHB 780SR

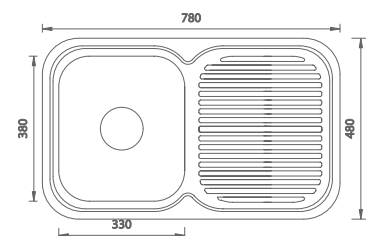

dimensions are in millimetres

Options to suit all omnia sinks

timber chopping board

RF 12



stainless steel draining basket

RF 15



stainless steel colander

RF 10 (½ bowl)

RF 11 (¾ bowl)



matisse

With extra width and bowl depth, the Matisse is a masterpiece of design

**double bowl +
single drainer**
1200 x 500 x 190
LHB M1200L &
RHB M1200R

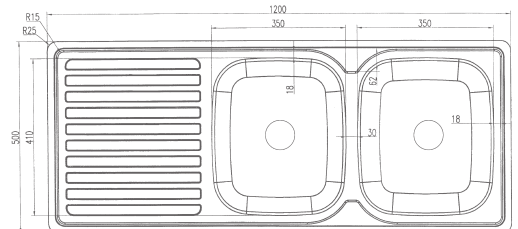

**1 & ¾ bowl +
single drainer**
1160 x 500 x 190
LHB M1160L &
RHB M1160R

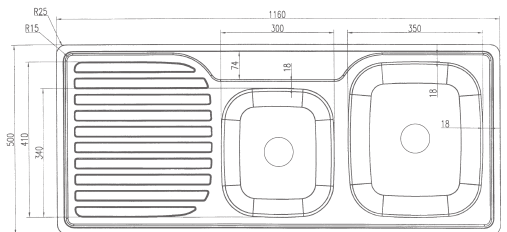

**1 & ½ bowl + single
drainer**
1020 x 500 x 190
LHB M1020L &
RHB M1020R

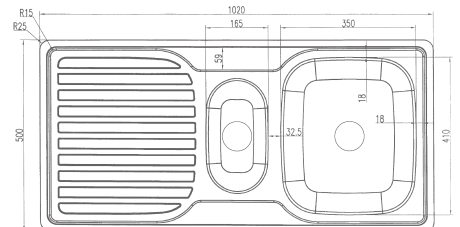
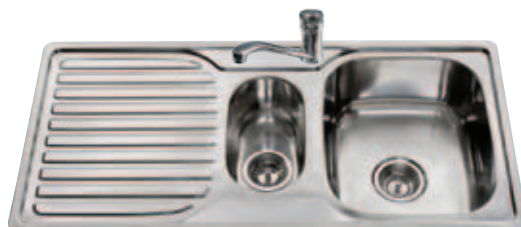

**single bowl +
single drainer**
820 x 500 x 190
LHB M820L &
RHB M820R

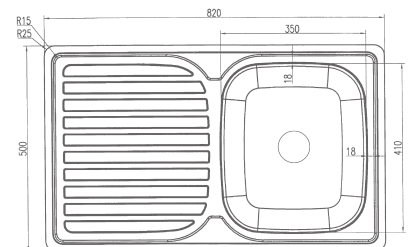

Accessories Included with all matisse sinks

**timber
chopping
board**
M12



**stainless
steel draining
basket**
M15



Optional accessory

**stainless steel
colander**
M 10 (½ bowl)
M 11 (¾ bowl)

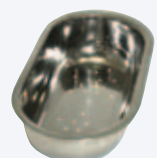

bellini undermount sinks

The Bellini range of undermount sinks is designed to maximise benchtop space

1 & ½ bowl - rectangle

805 x 520 x 200

LH UM805L &
RH UM805R

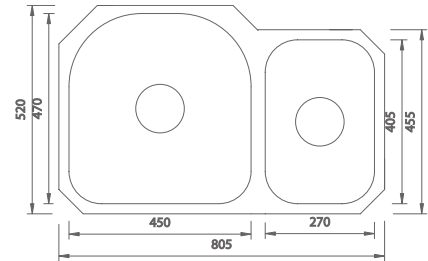

single bowl - rectangle

570 x 470 x 220

UM 570

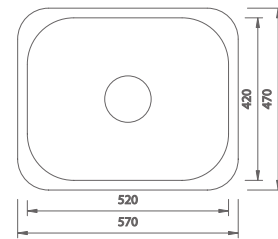

single bowl - rectangle

500 x 450 x 200

UM 500

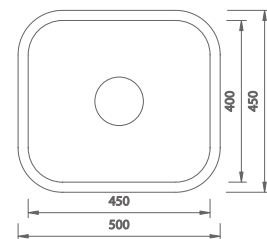

single bowl - rectangle

320 x 455 x 160

UM 320

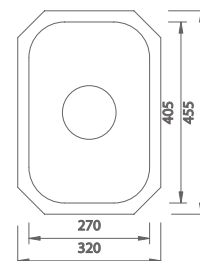

**double bowl -
rectangle**
880 x 500 x 200
UM 880

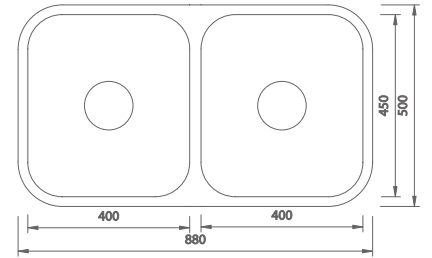

**double bowl -
rectangle**
1120 x 500 x 220
UM 1120

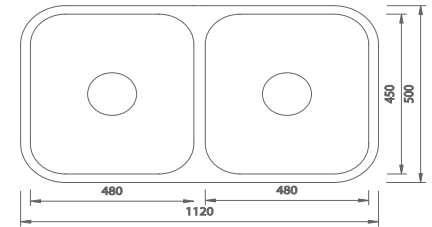
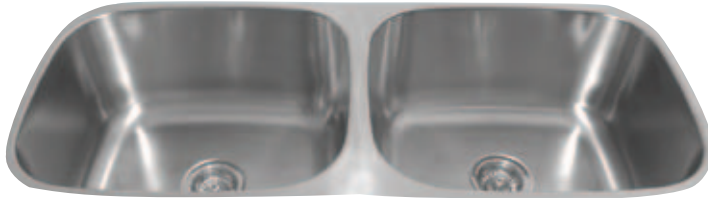

single bowl - round
435 x 435 x 200
UM 435

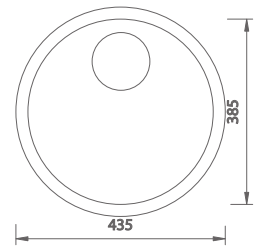

All RF sinks have the most sort after features:

- ▲ luxurious 'silk finish'
- ▲ large capacity deep bowls
- ▲ heavy duty tap landings
- ▲ basket wastes included for all bowls
- ▲ individually quality inspected
- ▲ made from a minimum 0.9mm thickness 18/10 stainless steel (undermount sinks 1.2mm)
- ▲ reinforced drainers for extra strength
- ▲ full size cut out templates included in all cartons

square undermount sinks

The striking NEW square range will add a touch of luxury to any home

Double Bowl - rectangle

938 x 510 x 254

UMSQ 938

- 1.2mm Thick S/Steel
- Sound deadening pads on all sides
- **Extra Deep Bowls 254mm**

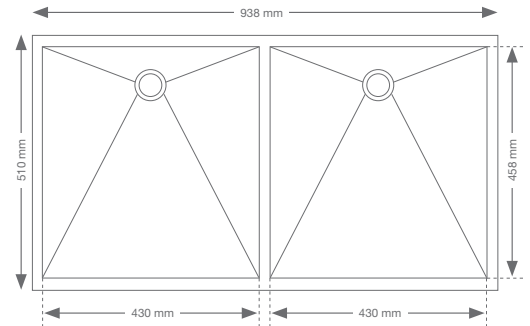

1 & ½ bowl - rectangle

738 x 510 x 254

UMSQ 738

- 1.2mm Thick S/Steel
- Sound deadening pads on all sides
- **Extra Deep Bowls 254mm**

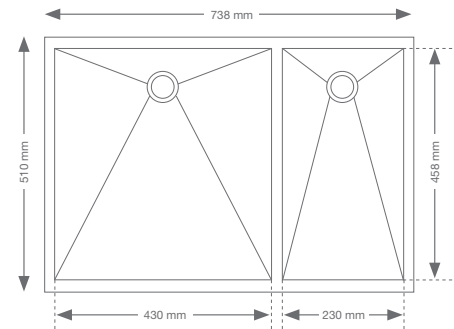

Single Bowl - rectangle

482 x 510 x 254

UMSQ 482

- 1.2mm Thick S/Steel
- Sound deadening pads on all sides
- **Extra Deep Bowl 254mm**

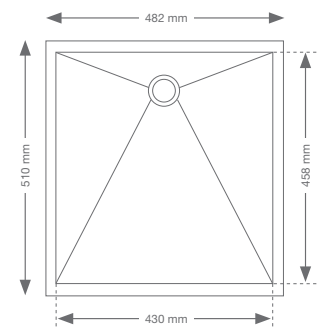

All RF Square Undermount Sinks have a depth of 254mm

Compare Other Sink Depths

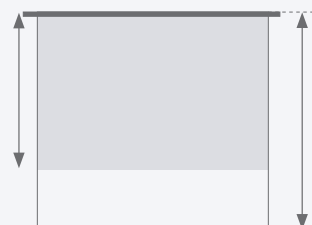

RF Sink Depth 254mm

laundry units & tubs

Choose from the innovative range of RF laundry units & tubs

**Timber Laundry Unit
Double Bowl**
2 x 45 L
1160 x 500 x 880
TLU 02

- Full Gloss Painted front & sides
- Recessed Toe Kick
- Shelf & Floor
- Basket Waste
- Soft Door Close

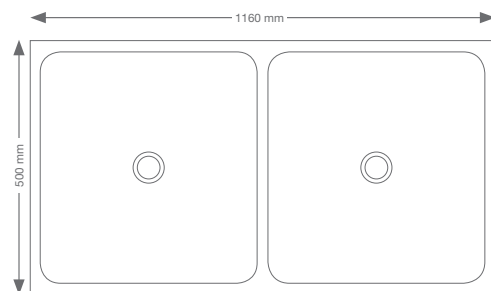

**Timber Laundry Unit
45 L**
630 x 460 x 880
TLU 01

- Full Gloss Painted front & sides
- Recessed Toe Kick
- Shelf & Floor
- Bypass Kit
- Basket Waste
- Soft Door Close

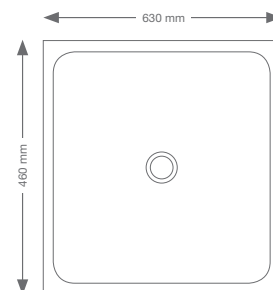

**Metal Laundry Unit
45 L**
630 x 460 x 880
MLU 02

- Timber Floor
- Bypass Kit
- Basket Waste
- Optional Adjustable Feet

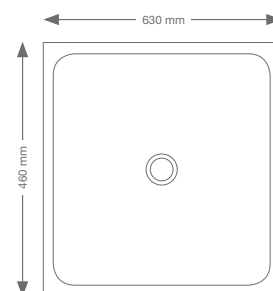

laundry units & tubs

Choose from the innovative range of RF laundry units & tubs

Metal Laundry Unit

35 L

560 x 460 x 910

MLU 01

- Child Proof Lock
- Shelf & Floor
- Adjustable Feet
- Bypass Kit
- Basket Waste

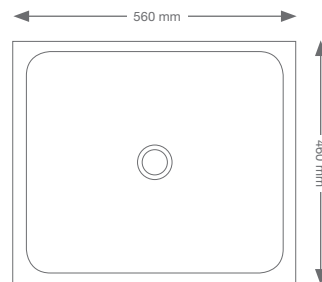

Double Inset Laundry Tub

1160 x 500 x 230

[bypass optional]

LT 200

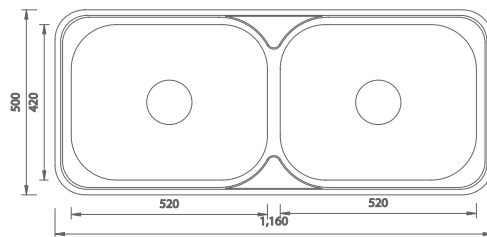

Single Inset Laundry Tub

630 x 470 x 230

[bypass included]

LT 100

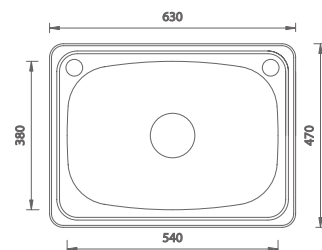

RF BATHROOM & KITCHEN
PRODUCTS PTY LTD
ABN 47 623 032 855

7 Mickle Street, Dandenong South 3164
Post Office Box 6228 Dandenong 3175
T: 03 9706 4775 F: 03 9706 4772
E: rfbath@bigpond.com
www.rfbath.com.au

DISTRIBUTOR



- > Specifications may change without notice.
- > Taps, mixers and accessories are not included and are sold separately.
- > All dimensions should be checked prior to installation.
- > Issue date May 2010